

DOME CLIMBER - M008602
FOR CHILDREN AGED 3 - 8 YEARS

SAFETY GUIDELINES

WARNINGS

ONLY FOR DOMESTIC USE. THIS PRODUCT HAS NOT BEEN DESIGNED FOR COMMERCIAL USE IN PLAY CENTRES, NURSERIES ETC.

ONLY SUITABLE FOR OUTDOOR USE.

NOT FOR CHILDREN WITH A BODY WEIGHT OVER 45KG.

MAXIMUM 3 CHILDREN ON THE DOME AT ANY TIME.

NOT FOR CHILDREN UNDER 3 YEARS DUE TO SMALL COMPONENT WHICH MAY CAUSE CHOKING HAZARD.

NO CHILDREN TO BE INSIDE THE DOME WHEN OTHERS ARE CLIMBING OVER THE TOP.

This equipment must be assembled and checked by an adult. Two adults may be required to assemble this product.

Adult supervision is required at all times.

Before use please check all bolts are tight, secure and intact.

Check all coverings for bolts and sharp edges and replace when required.

Check bars and attachments if relevant to your product for evidence of deterioration. Replace when required in accordance with the manufacturers instructions if necessary.

Place the product on level surface at least 2 metres from any structure or obstruction such as a fence, garage, house, wall, overhanging branches, laundry line or electrical wires.

DO NOT install the product over concrete, asphalt or any hard surface.

DO NOT orientate the product directly towards the sun.

Leave all fittings finger tight until assembly is complete, for ease of construction. Then tighten firmly.

Children should not wear cycle helmets whilst on this equipment.

Do not allow loose, hooded or baggy clothes to be worn as children can get trapped and may be unable to free themselves.

Do not allow children to climb on parts of this equipment not intended for this purpose.

Do not allow children to wander into the play area whilst the equipment is in use.

Regularly check the item for wear and damage, removing the item from use when necessary until replacement parts are fitted.

Do not modify the item.

Failure to assemble and maintain this item as per instruction may cause injury to the user.

Please keep the instructions in a safe place for future reference.

Made in China to European Standards.

Conforms to EN71

DOME PARTS LIST

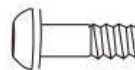

Bolt M8*38mm (20 pcs)



Washer (20 pcs)



Flay Nut M8 (20 pcs)



Allen Key (1pc)



Spanner (1pc)



Large Node (12 pcs)



Small Node (8 pcs)



Ground Peg: 4 pcs



Tube A (5pcs)



Tube B (20pcs)



Tube C (24pcs)

IMPORTANT: Make sure you read the safety notice on the front page and always supervise children while they are playing on the equipment. Once assembly is completed carefully check equipment. In the unlikely event that you do find any problems, please contact us. Do not allow children to use this product until the problem has been corrected.

STEP 1 : Assembly

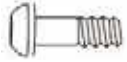

Bolt M8*38mm (8 pcs)



Tube A (4 pcs)



Washers (8 pcs)



Tube B (4 pcs)

Assemble as illustrated below.

Lay the round base using tubes A and B, and connect them together with bolts.
DO NOT FIT NUT AT THIS STAGE.

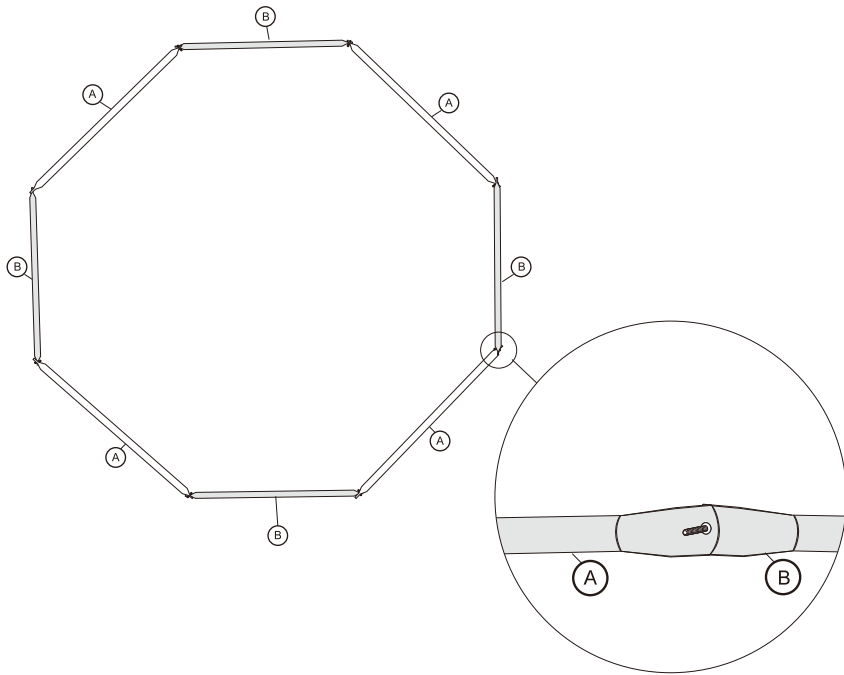

HINT: The screws go through from the inside out.

The convex side of the tube always faces inward of the dome.

STEP 2 : Assembly



Tube C (4 pcs)



Bolt M8*38mm (4 pcs)

X4



Washers (4 pcs)



Flay Nut M8 (4 pcs)

Assemble as illustrated below.

Six Tube C are used to form a hexagon with one bolt and one flat nut.
Repeat to form four hexagons.

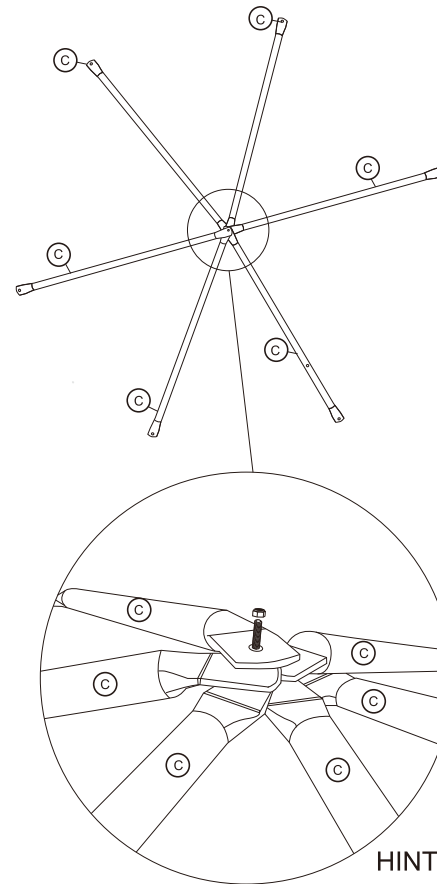

HINT: The screws go through from the inside out.

Do not fully tighten the nuts at this stage.

STEP 3 : Assembly

Assemble as illustrated below.

Assemble four hexagons (Step 2) onto the round base (Step 1).
Join two tube C from one hexagon to tube B on the base using bolt.
DO NOT FIX WITH NUT AT THIS STAGE

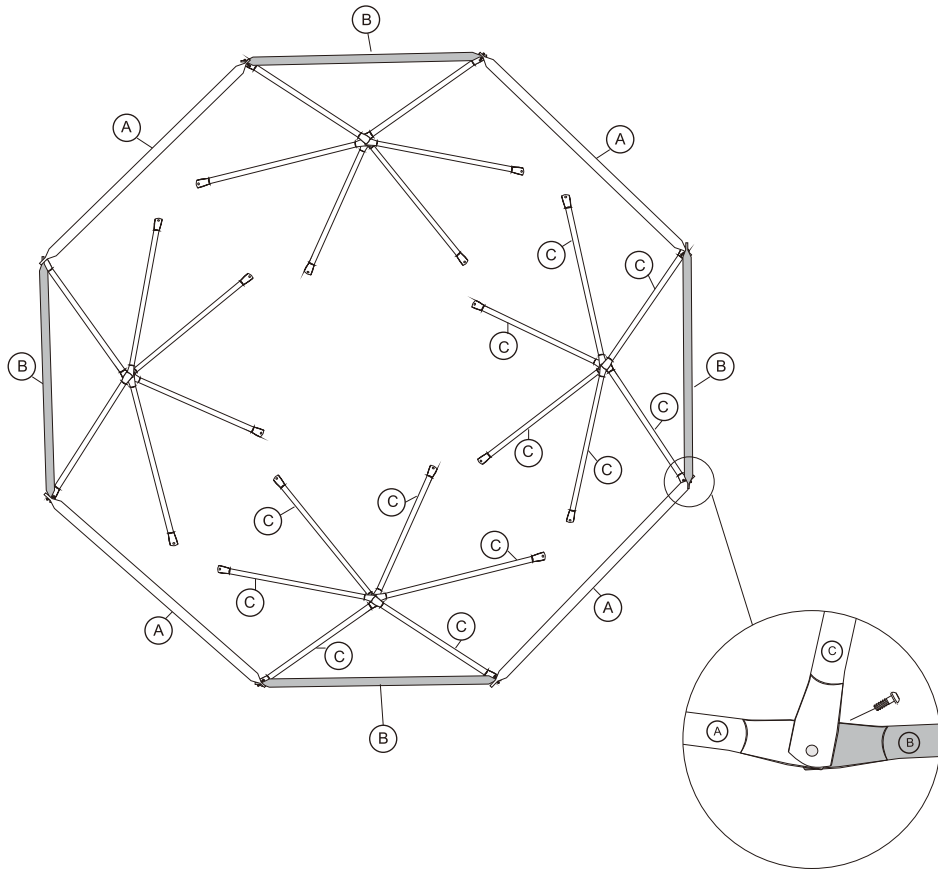

STEP 4 : Assembly



Tube B (12 pcs)



Bolt M8*38mm (4 pcs)



Washers (4 pcs)



Flay Nut M8 (12 pcs)

Assemble as illustrated below.

Join the hexagons together by adding two Tube B to Tube A on base, fix with nut.
Connect a third Tube B using nut to lock in place.
Now the base on the dome is completed.

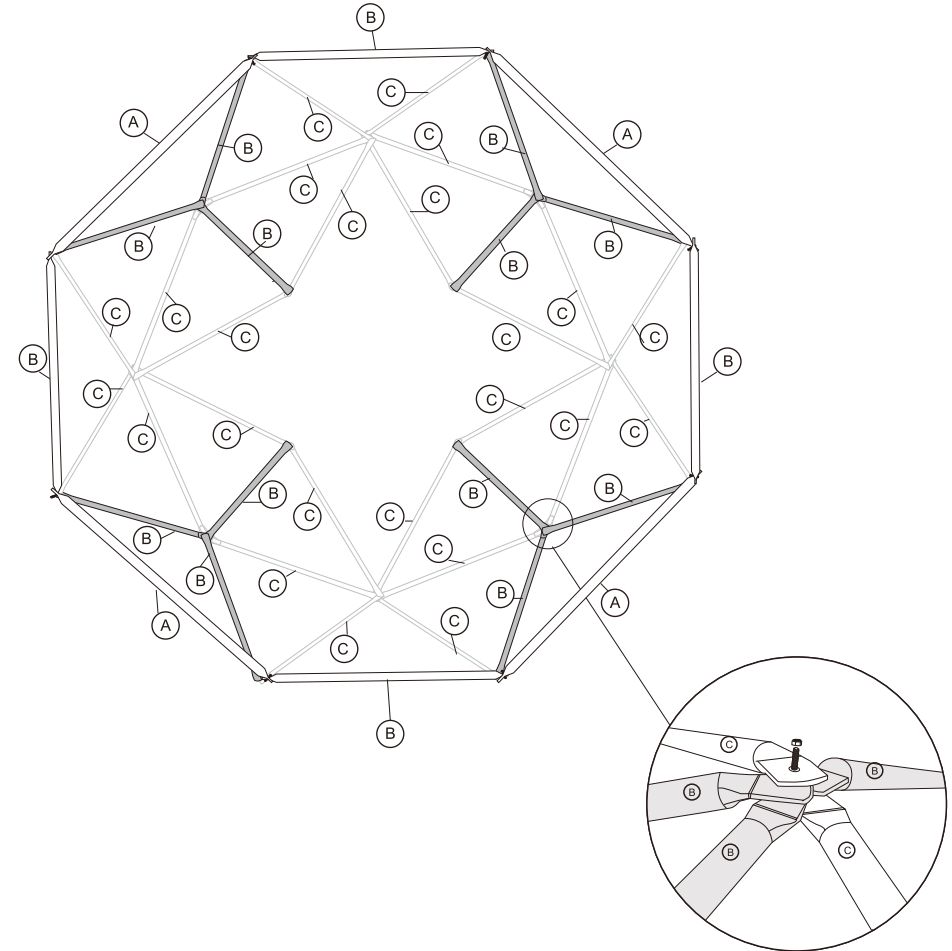

STEP 5 : Assembly



Tube B (4 pcs)

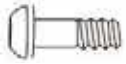

Bolt M8*38mm (4 pcs)



Flay Nut M8 (4 pcs)



Washers (4 pcs)

Assemble as illustrated below.

Connect the top of the hexagons using final four Tube B, fixing in place with nut.

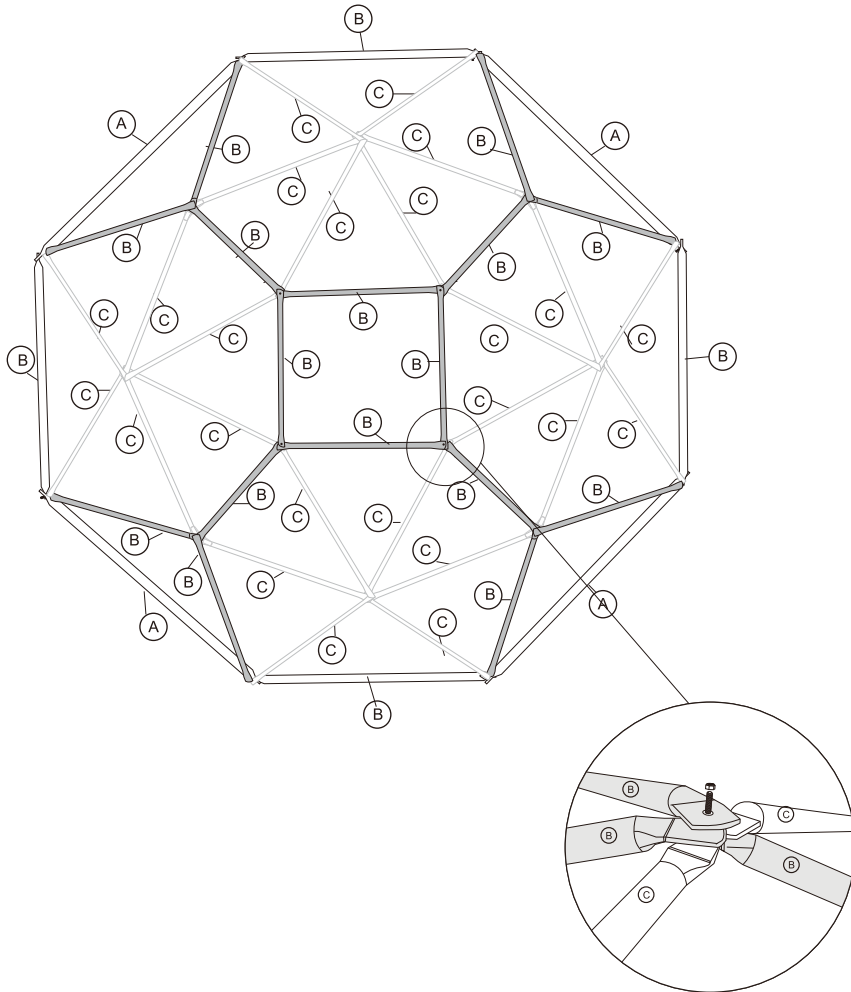

STEP 6 : Assembly

Assemble as illustrated below.

Join the final Tube A to the top square, replacing nut afterwards.

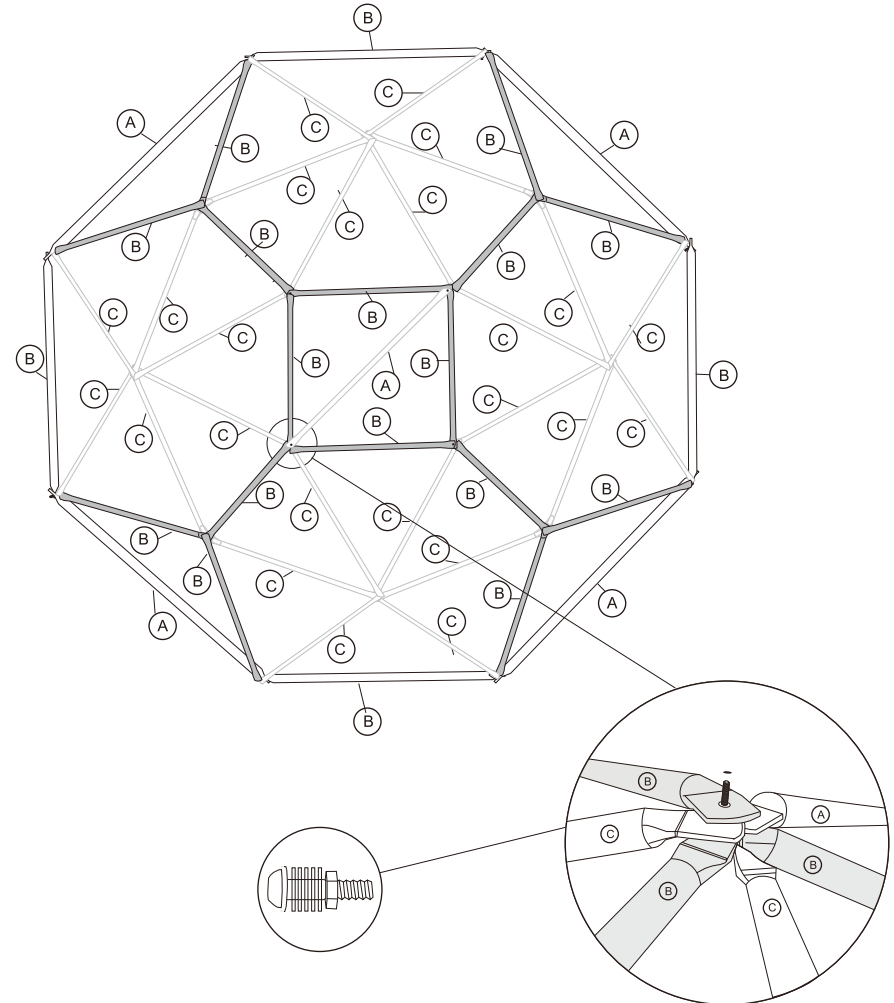

HINT: Please fully tighten all the bolts and nuts until snug.

STEP 7 : Assembly



Small Node (8 pcs)

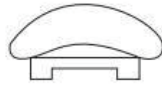

Large Node (12 pcs)



Allen Key (1pc)

Assemble as illustrated below.

Cover the joins of the base with the small nodes x 8.
Cover the joins of remaining structure with large nodes x 8.
Use the allen key to tighten the nodes in place.

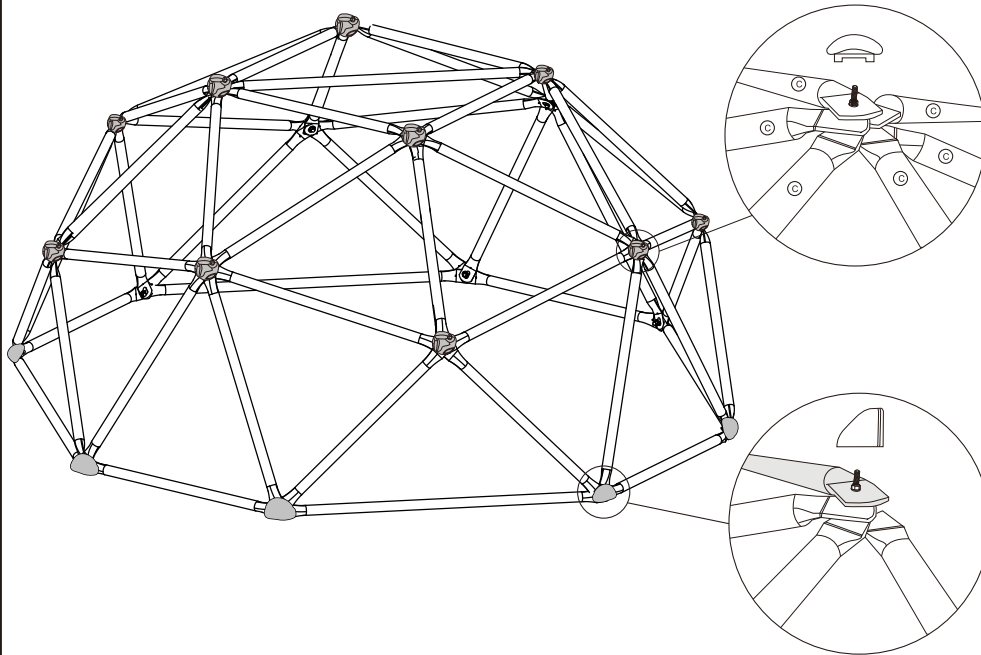

IMPORTANT: Ensure the notch of large node fits over the top of the tube join.

STEP 8 : Assembly

Fully Assembled

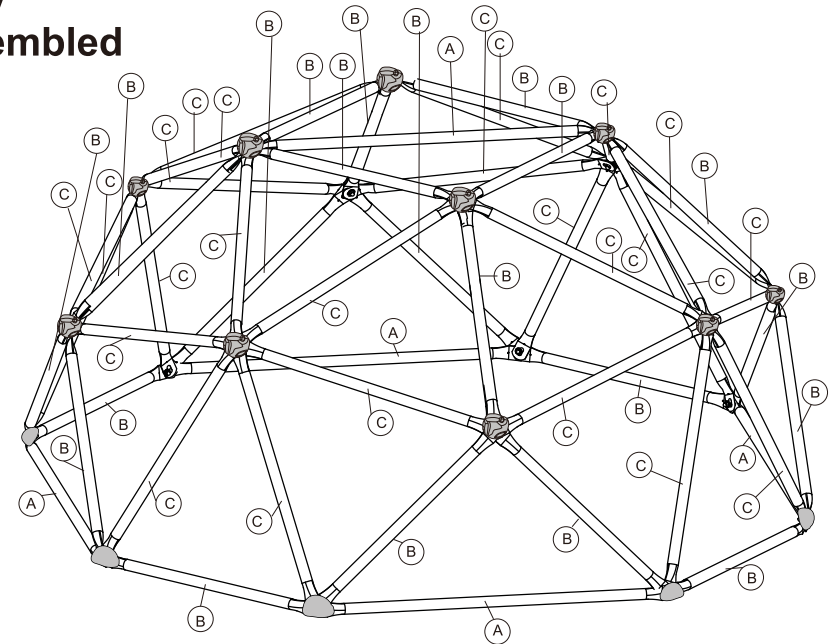

STEP 9 Anchoring the Dome Climber

IMPORTANT: For safety reasons this dome climber MUST be anchored and concreted into the ground. If you are uncertain about this procedure, telephone our helpline number."

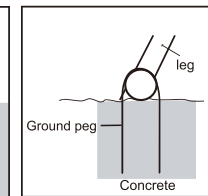
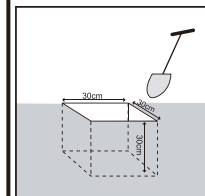

P Peg allocation point

WARNING:
TIGHTEN ALL HARDWARE BEFORE USING.
WHEN PLAYGROUND EQUIPMENT IS DISCARDED,
THE EQUIPMENT SHOULD BE DISSASSEMBLED AND
DISPOSED OF WITHOUT ANY UNREASONABLE DANGER.

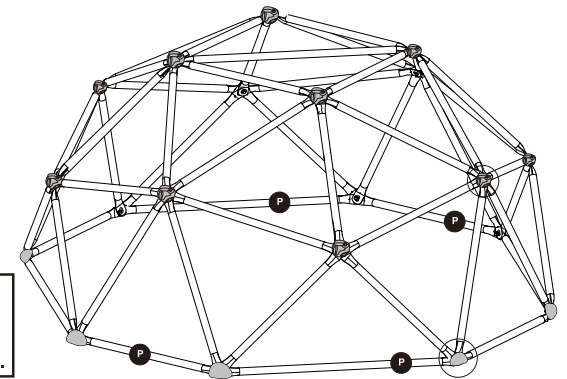

MV Sports & Leisure Ltd.
35 Tameside Drive
Castle Bromwich
Birmingham B35 7AG
United Kingdom
email: info@mvsports.com
www.mvsports.com

CUSTOMER SERVICES

MV has taken great care to ensure that this toy has reached you in good condition. Should you have a query, please contact: customer.services@mvsports.com where your query will be dealt with promptly. Alternatively, you can call on 0121 748 8017.



This mark denotes compliance with the standards laid down by the E.C. (European Community)

It is in your best interest to keep a note of our name and address for future reference. If you have any complaints or find this product to be faulty, in order to avoid any delay, please contact the distributor at the address shown below.

Vulcan Consulting
EU Authorised Representative, The Merrion Buildings - Iconic offices, 18-20 Merrion Street, Dublin 2, D02 XH98, Ireland.